

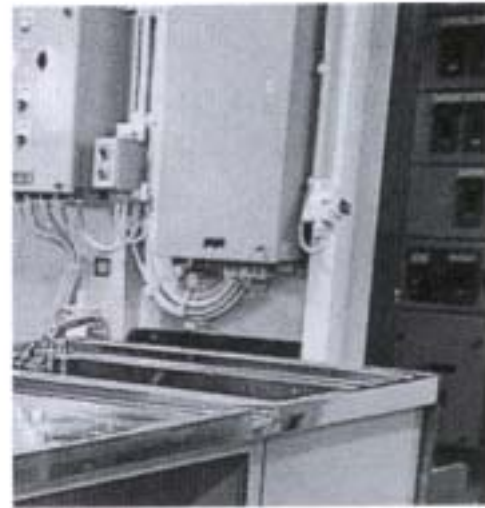

MARINE CATERING FURNITURE

厨房家具・厨房機器・鋼製家具類
限られたスペースを生かす、大晃オリジナル船用製品



流し台 Dresser with sink



DRESSER WITH 1-SINK

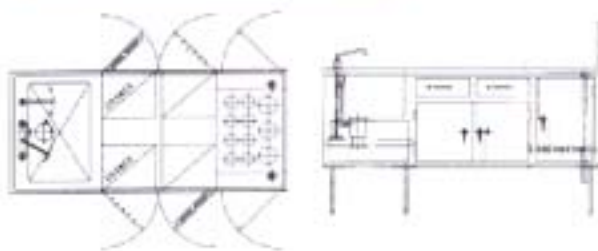

Free size &
Free lay-out

R Right sink 右槽
L Left sink 左槽
D Drawer 引き出し

1RS-3D



DRESSER WITH 2-SINKS

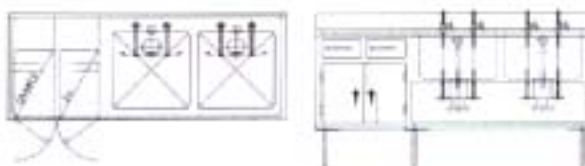

2RS-2D



SPLASH
BACK

A
TYPE



R
TYPE



L
TYPE



B
TYPE



配膳台 Serving table



調理台 Cooking table



Pattern

ST-2D

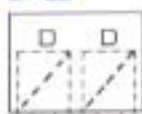

ST-3D

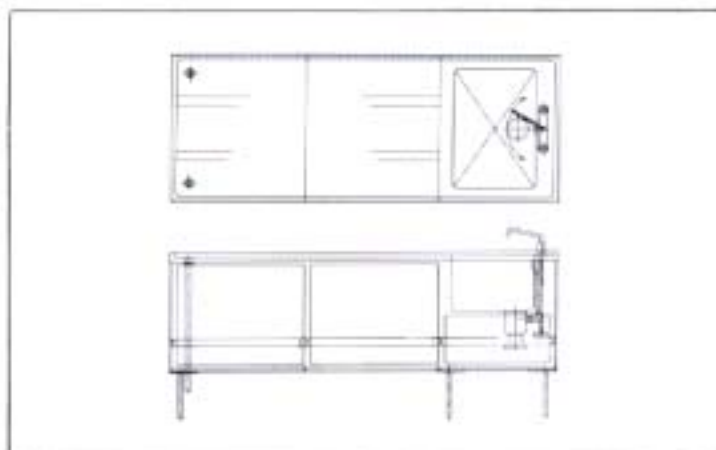
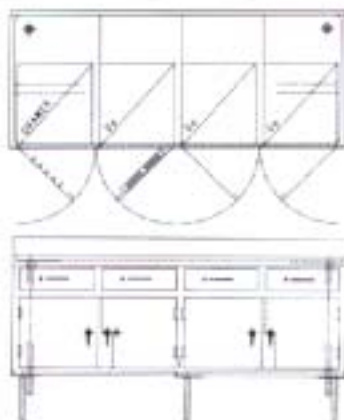
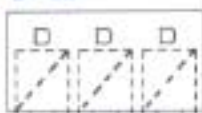

機器 Machines and tools

操作性・安全性に優れた
清潔設計です。

① 電気湯沸器



② 電気レンジ



③ 保温・保冷庫

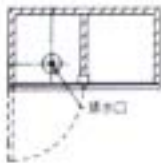

④ デイスポーター

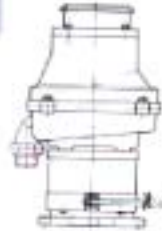
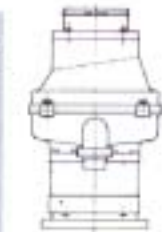

浴槽 Bath tub (オーダーメイドバス)

熱・汚れ・サビに強く、保温
性にも優れたステンレス製
浴槽、しかも軽量設計です。

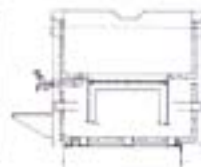

配膳棚 Food locker with A-0 Type Door



サービスハッチ Service hatch TK.SH-1(A-0)

(横スライド式)

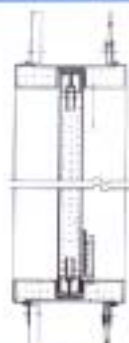
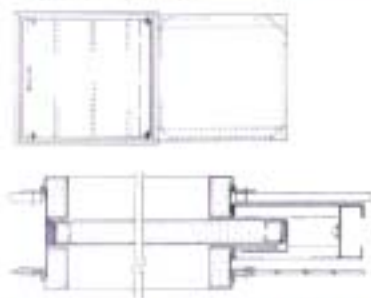

(上下スライド式)



フード Galley hood (材質はスチール又はステンレス)

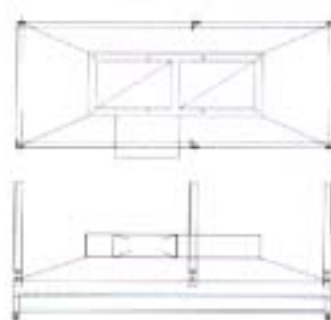
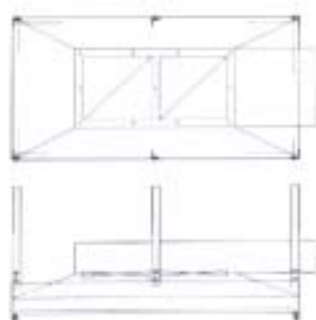

鋼製家具類 Steel Furniture



防火扉・厨房家具・T・Sパネル
防音エンクロージャー・ディーゼル機関用排気消音器
設計・製造・販売

 大晃産業

本社 / 〒722 広島県尾道市外向島町9515-1
TEL (0848) 44-5000代
FAX (0848) 44-5779